

Left-side view

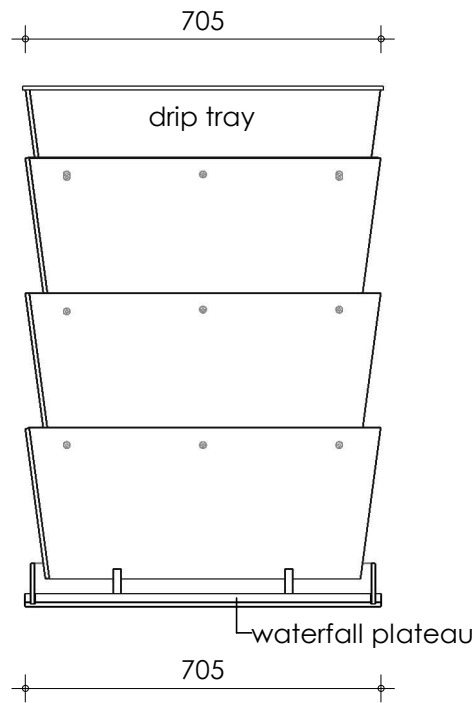

Front view

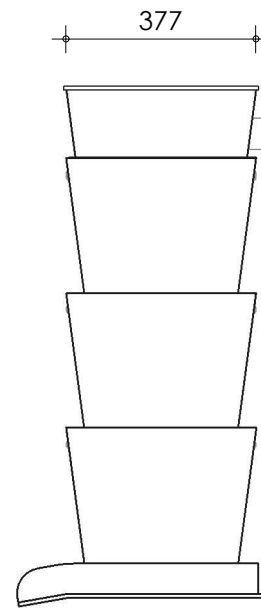

Right-side view

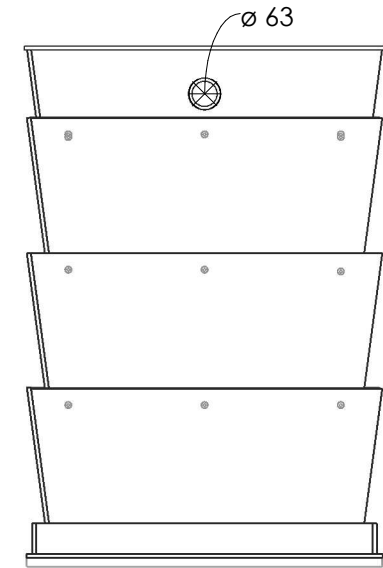

Rear view

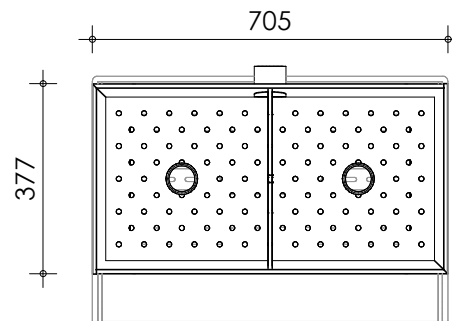

Top view

Filter media

Bacteria House - 308 rods (2 boxes)

description:

TF60 - Trickle filter - drip tray /
waterfall plateau

scale :

1 : 15

date/version :

v.3